



RIPPLE



## 2020 MADE IN THE UK

---

WE ARE PROUD TO BE DESIGN LED, UK FURNITURE MANUFACTURERS. SPECIALISING IN SOFT SEATING, ACOUSTIC SCREENS, MODULAR SYSTEMS, DINING AND LAMINATED FURNITURE PERFECT FOR ENHANCING ANY ENVIRONMENT.

FORMED IN 2012 AND USING THE LATEST CNC TECHNOLOGY, IN-HOUSE DESIGNERS AND HIGHLY SKILLED CRAFTSMAN AND ENGINEERS WE HAVE THE KNOWLEDGE, UNDERSTANDING AND VISION IN DEVELOPING BEAUTIFUL RANGES OF HIGH QUALITY FURNITURE.

WE ALSO CREATE LONG LASTING RELATIONSHIPS WITH OUR DEALER PARTNERS AND ARE EXTREMELY FLEXIBLE IN OUR APPROACH PRODUCING AN ARRAY OF MADE TO MEASURE ITEMS AND COMPLETELY BESPOKE PIECES TO MEET THE NEEDS OF ANY PROJECT.





## RIPPLE

If you are looking for high usage seating or dining areas then look no further than Ripple. With a strong structure and high laminated screens it is designed to withstand even the most demanding of education and commercial environments. A padded seat and 'Ripple' back make this range both comfortable as well as practical

and sturdy. Whether you are looking to create back to back seating booths, perimeter dining areas or a sweeping S formation then Ripple can be configured to meet the demands of your project.





# RIPPLE

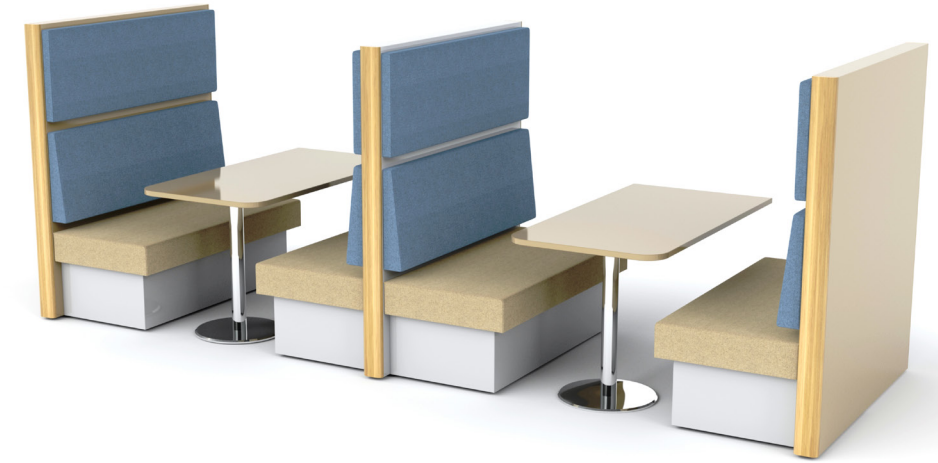



RIP 1

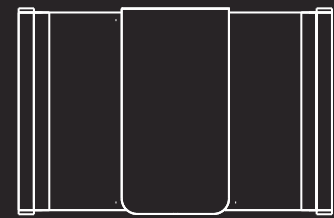
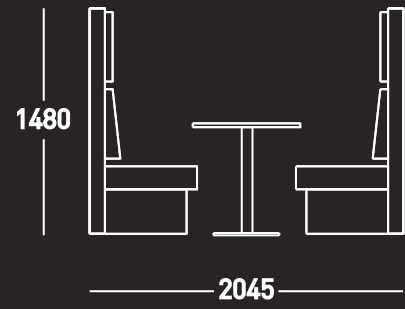

1270

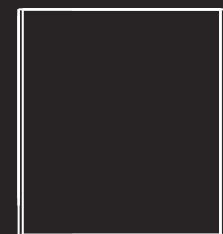

RIP 2

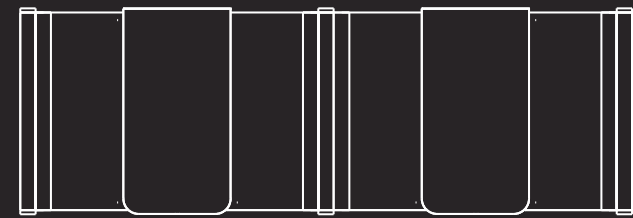
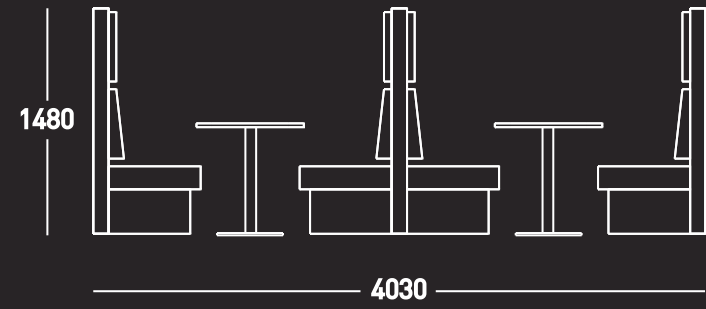

1270

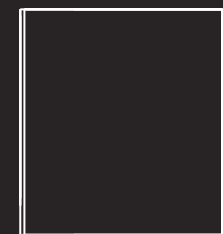

RIP 3

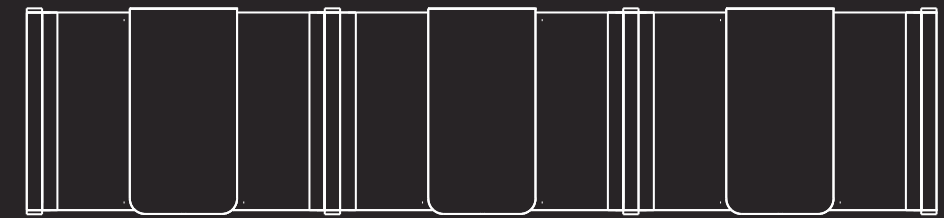
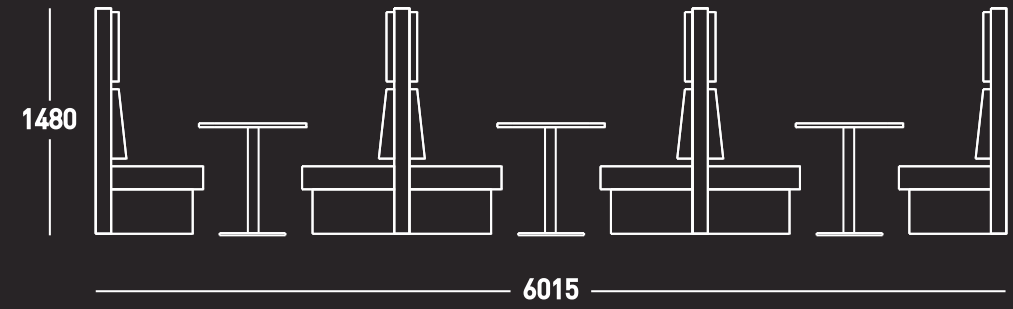

1270





RIP 4

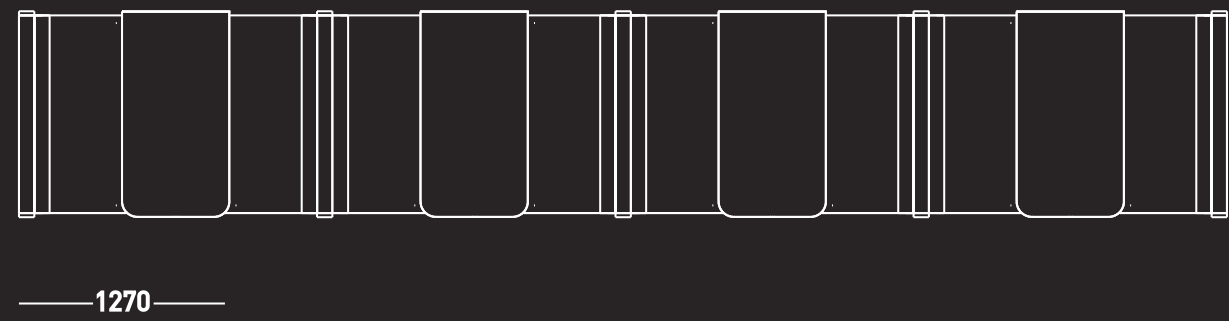
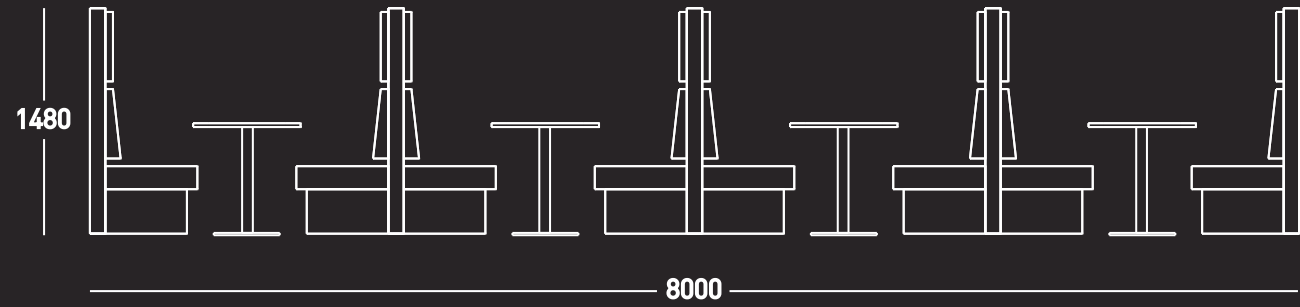

RIP 1 ST

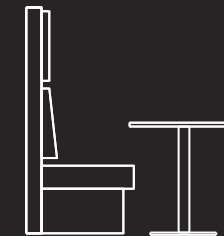
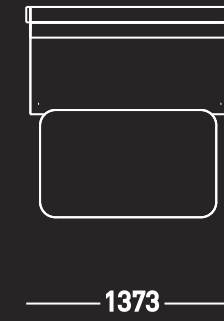

RIP 2 ST

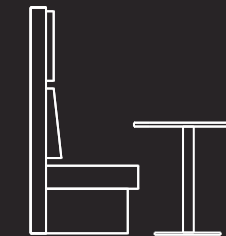
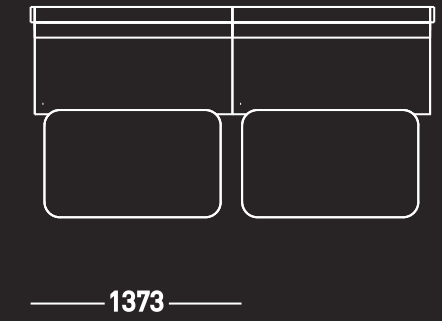
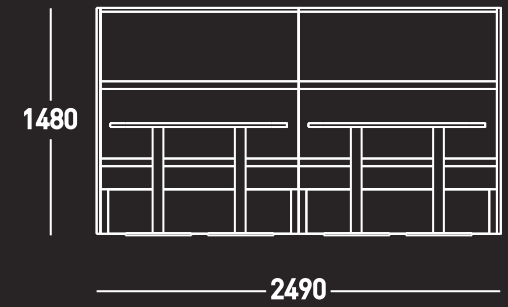



RIP 3 ST

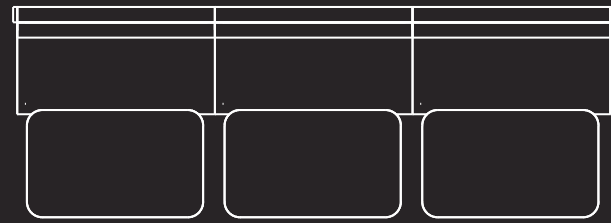
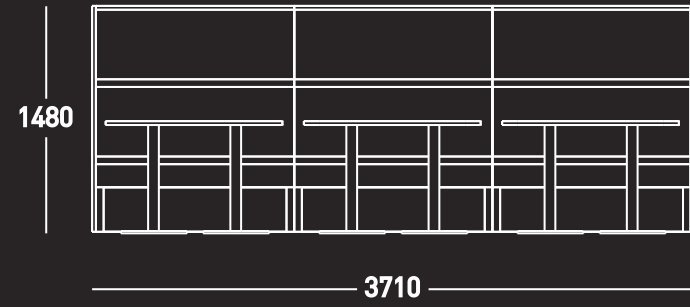

1373



RIP 1 BB

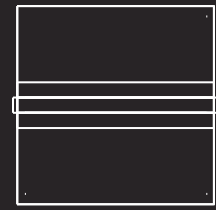
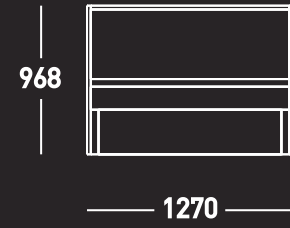

1300

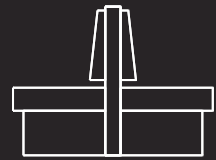



## FABRIC SPECIFICATION :

WE PROVIDE THE FURNITURE UPHOLSTERED IN VARIETY OF FABRICS AVAILABLE. THE MOST COMMON USED RANGES ARE:

Camira™ ADVANTAGE/ X2/ SYNERGY/ BLAZER;

Chieftain™ JUST COLOUR;

Panaz™ ULTIMATE TOUCH.

THE FURNITURE CAN ALSO BE UPHOLSTERED IN MANY OTHER RANGES UPON REQUEST.

## WORKTOPS & LAMINATES :

AS WELL AS WITH THE FABRICS, THE FINISHES FOR THE HARDSURFACES COME IN VARIETY OF RANGES AND COLOURS. THE MOST RECOMMENDED PRODUCERS ARE:

Altofina™ / Abet™/ Egger™/ Formica™ & Kronospan™

## METAL LEGS & TABLE BASES :

THE METAL PARTS OF THE FURNITURE COME IN DIFFERENT FINISHES, AS:

STAINLESS STEEL; CHROME; RAL COLOURS (UPON REQUEST)

## WARRANTY :

5 YEAR – NORMAL FAIR WEAR & TEAR.

THIS INCLUDES THE STRUCTURE AND FOAM/PADDING MATERIALS.

FABRICS COVERED BY FABRIC MANUFACTURERS' WARRANTY, USUALLY 5 YEARS, DEPENDANT ON FABRIC CHOICE.

EXPECTED LIFE CYCLE OF 15 YEARS .

## CARE INSTRUCTIONS

### General Maintenance:

Vacuum regularly to remove dust and grit.

Clean spills and stains quickly to prevent them setting in

If being used in a spill/stain-prone area specify a stain repellent finish.

For appearance retention we recommend regular professional cleaning to give your furniture a longer life.

### Natural Fabrics:

In addition to regular vacuuming, wool and other natural fibres can usually be cleaned using branded upholstery shampoo.

For a deeper clean, it's best that wool be dry cleaned, as over wetting cause shrinkage and change in appearance.

Never apply bleach, ammonia, alkali or strong acids to wool upholstery.

### Synthetic Fabrics:

Vacuuming is the best regular maintenance, followed by speed of action to remove spills and stains rapidly as soon as they occur.

Most synthetic fabrics can be wiped down with a water soaked damp cloth without fear of damaging the fibre or removing the colour.

Stubborn stains can be removed with upholstery shampoo.

### Leather:

Leather should be regularly dusted with a soft cloth and vacuumed with soft brush extension.

Most types of Anilines can also be treated with specialist products to help preserve, colour, finish etc..

As leather is natural material, discrepancies in surface texture and 'puddling' in seat areas is to be expected.





**2020<sup>®</sup>**  
**FURNITURE DESIGN**

**BRIGADE HOUSE  
ALINGTON ROAD  
LITTLE BARFORD  
ST NEOTS  
PE19 6WG**

**TEL: 01767 677 256  
E-MAIL: SALES@2020FURNITUREDESIGN.CO.UK**